

KRS

Next Generation Patient Movement Management



KRS

In Radiotherapy

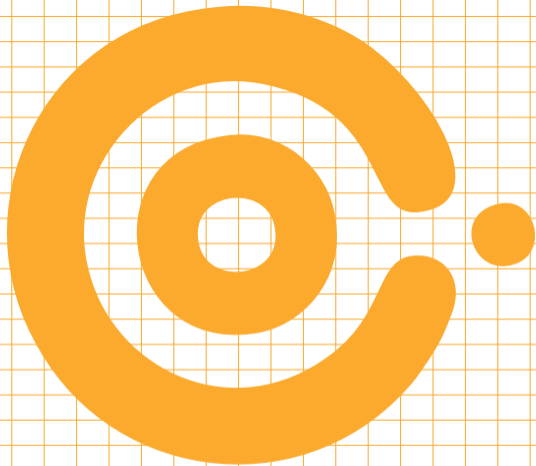

KRS

Kalyani Radiotherapy Specialty India (P) Ltd,
A-6 Vignesh Plaza, No: 11, First Floor, Thillainagar, Trichy-620018. India.
Tel: +91 (0)431 2760433 E-mail: info@krs-ipl.com

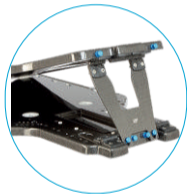
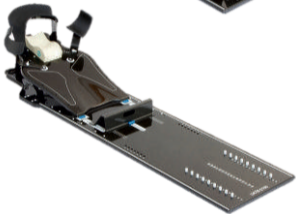
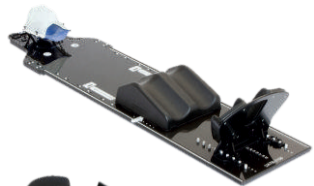

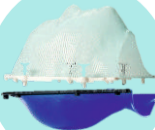
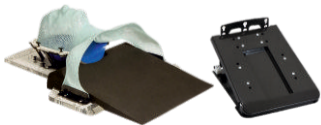
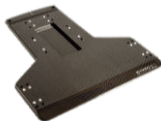
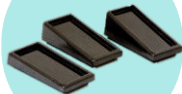
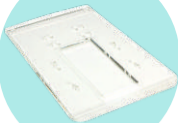

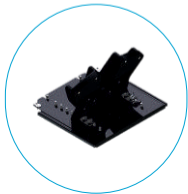
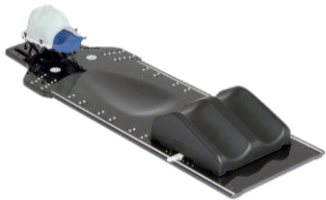

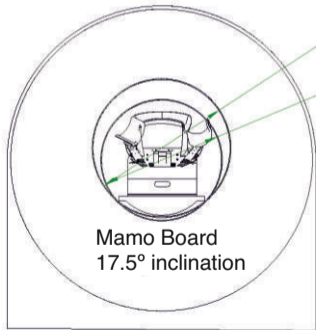

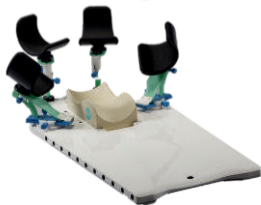

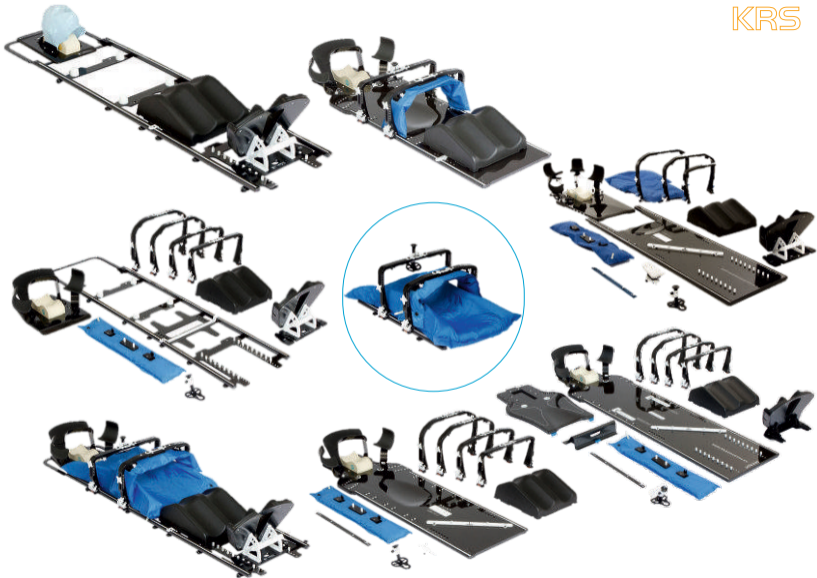

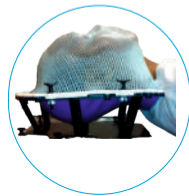
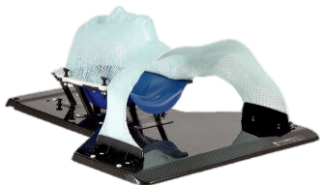
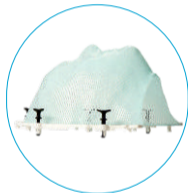

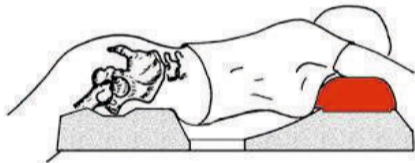
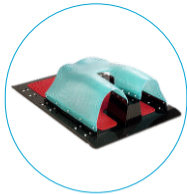



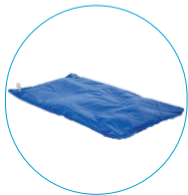
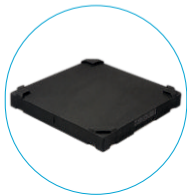
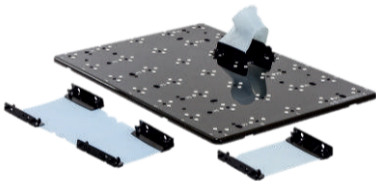
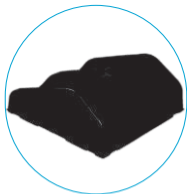

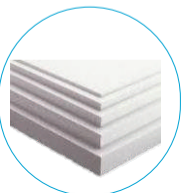
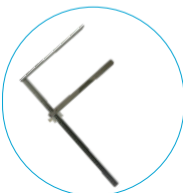
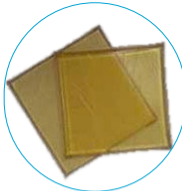
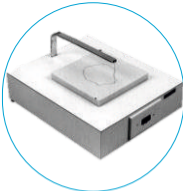

CUSHIONS

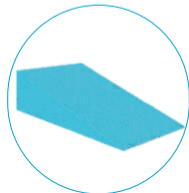
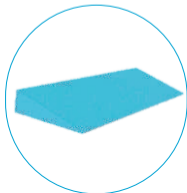
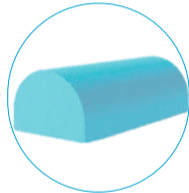
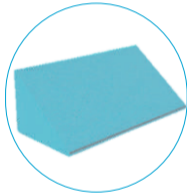
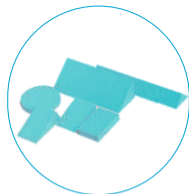
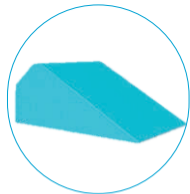

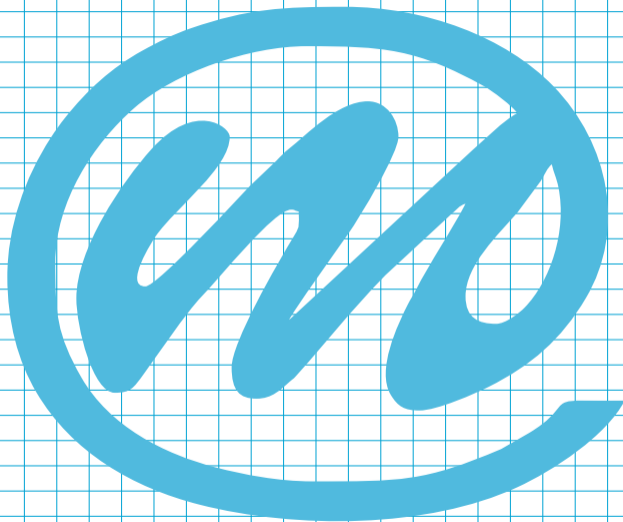



macromedics

SOLUTIONS IN RADIOTHERAPY

MacroMedics BV
Kouwe Hoek 18
2741 PX Waddinxveen
The Netherlands

Tel: +31(0)182 389777 Fax:
+31(0)182 389778
info@macromedics.com
www.macromedics.com